

## ATG Technical Approval with Certification



Main structure products

Base blocks

**MARMOX THERMOBLOCK**

Valid from 09/01/2018  
until 08/01/2023

Approval and Certification Body



**BCCA**

Belgian Construction Certification  
Association

Rue d'Arlon, 53, B-1040 Brussels  
[www.bcca.be](http://www.bcca.be) - [info@bcca.be](mailto:info@bcca.be)

### Approval holder:

Albintra nv  
Bistweg 80  
B-2520 BROECHEM  
Tel: +32 (0)3 470 12 12 - Fax : +32 (0)3 470 12 00  
Website: [www.albintra.be](http://www.albintra.be)  
E-mail: [info@albintra.be](mailto:info@albintra.be)

## 1 Objective and scope of the Technical Approval

This Technical Approval is based on the favourable evaluation of the system (as described above) by an independent Approval Body designated by UBAtc, BCCA, for the application mentioned in this Technical Approval.

The Technical Approval serves as a record of the approval inspection. This inspection consists of the following: identification of relevant properties of the system for the intended application, laying/installation method, system design and reliability of production.

The Technical Approval provides a high level of reliability, based on the statistical interpretation of inspection results, regular monitoring, adjustments in order to keep abreast of the situation and latest technical developments and quality monitoring by the Approval Holder.

In order to retain the Technical Approval, the Approval Holder must continuously provide evidence that he is taking all necessary steps to demonstrate that the system is suitable for use. In order to do so, it is vital that the conformity of the system with the Technical Approval is monitored. This monitoring is entrusted by the UBAtc to an independent certification body known as BCCA.

The approval holder is required to adhere to the inspection results described in the technical approval if they make information available to third parties. The UBAtc or certification body may take any steps that become appropriate if the approval holder [or the distributor] fails to do so (to a sufficient extent) of his own accord.

The Technical Approval and certification for conformity of the system to the Technical Approval are independent of tasks conducted individually. The contractor and/or architect remain fully responsible for the conformity of the completed work with the provisions contained in the specifications.

The technical approval is not concerned, except in specifically included provisions, with on-site safety, health and safety aspects and the sustainable use of raw materials. As a result, the UBAtc shall not be responsible, under any circumstances, for any damage caused by the failure of the approval holder, contractor(s) and/or architect to respect provisions relating to on-site safety, health aspects and the sustainable use of raw materials.

Note: in this technical approval, the word "contractor" will always be used, when referring to the entity that completes the work. This word has the same meaning as other frequently used words, such as "operator", "installer" and "fitter".

## 2 Object

Marmox THERMOBLOCKS® are insulation masonry blocks intended for base layers and consist of insulation material. Their lower and upper sides are coated with a polymer-modified cement mortar reinforced by an alkali-resistant glass fibre mesh. The insulation material consists of a core made from extruded polystyrene foam (XPS) or polyisocyanurate foam (PIR), in which polymer-modified concrete cylinders are placed at regular intervals. The cylinders are firmly attached to the upper and lower layers. Marmox THERMOBLOCKS® are used as a base block in supporting and non-supporting masonry, in order to prevent heat losses at the base of outside walls and provide a solution for the problem of thermal bridging. The scope of application is limited to its use as a base layer in masonry walls consisting of clay bricks.

The approval covers non-supporting/non-load bearing walls and supporting walls subject to vertical loads, as well as walls subject to horizontal loads or shear stress, due to the properties of the finished product mentioned in § 7.

## 3 Materials and components

Preliminary note: materials other than those mentioned below only fall within the scope of this ATG if they are listed in a catalogue that is clearly labelled as being linked to this approval.

### 3.1 Component 1: XPS

In compliance with NBN EN 13164, the extruded polystyrene (XPS) has been assigned a CE AVCP 3 certificate. The properties of the XPS are mentioned in Tabel 1.

**Tabel 1 – Characteristics of the XPS**

Thickness	Characteristic	Specification	Standard
50 mm	Dimensional tolerance	T1	NBN EN 823
	Compressive strength	250 kPa	NBN EN 826
	Tensile strength	400 kPa	NBN EN 1607
	Fire reaction class	E	NBN EN 13501-1
	Water absorption coefficient by immersion	0.7%	NBN EN 12087
	Water vapour diffusion resistance	50	NBN EN 12086
	Thermal conductivity	0.029 W/m.K	NBN EN 12667
100 mm	Dimensional tolerance	T1	NBN EN 823
	Compressive strength	250 kPa	NBN EN 826
	Tensile strength	400 kPa	NBN EN 1607
	Fire reaction class	E	NBN EN 13501-1
	Water absorption coefficient by immersion	0.7%	NBN EN 12087
	Water vapour diffusion resistance	50	NBN EN 12086
	Thermal conductivity	0.029 W/m.K	NBN EN 12667

### 3.2 Component 2: PIR

In compliance with NBN EN 13165, the polyisocyanurate foam (PIR) has been assigned a CE AVCP 3 certificate. The properties of the PIR are mentioned in Tabel 2.

**Tabel 2 – Characteristics of the PIR**

Characteristic	Performance	Standard
Dimensional tolerance	Class T2	NBN EN 823
Compressive strength	130 kPa	NBN EN 826
Fire reaction class	F	NBN EN 13501-1
Water absorption coefficient by immersion	2 %	NBN EN 12087
Water vapour diffusion resistance	148	NBN EN 12086
Thermal conductivity	0.023 W/m.K	NBN EN 12667

### 3.3 Component 3: glass fibre framework

The alkali-resistant glass fibre framework is supplied in rolls that are 100 m long and 615 mm/930 mm wide. Its characteristics are as listed in Tabel 3

**Tabel 3 – Characteristics of the glass fibre framework**

Characteristic	Performance
Mesh size	5 mm x 10 mm
Density	110 g/m <sup>2</sup>
Tensile strength (in both directions)	1300 N/5 cm

### 3.4 Component 4: Nano-polymer concrete

The polymer-modified concrete is produced in situ and prepared using, for example, a base made from CNT-modified epoxy binder, 0/6 aggregates, recycled polystyrene, adjuvants and fillers.

**Tabel 4 – Characteristics of the nano-polymer concrete**

Property	Specification
Density	1100 kg/m <sup>3</sup>
Compressive strength	60 N/mm <sup>2</sup>
Thermal conductivity (10,dr, 90/90)	0,13 W/mK

### 3.5 Component 5: Nano-polymer mortar

The polymer mortar in the lower and upper layers, which is produced in situ, is a polymer-modified cement mortar prepared using a cement base made from CEM I 42, R and local sand.

**Tabel 5 – Characteristics of the nano-polymer mortar**

Property	Specification
Density	1900 kg/m <sup>3</sup>
Compressive strength	20 N/mm <sup>2</sup>

### 3.6 Marmox THERMOBLOCK® mortar

Dry masonry mortar intended for normal use in compliance with NBN EN 998-2, G type, CE-AVCP 2+, with properties as listed in Tabel 6.

**Table 6 – Characteristics of the THERMOBLOCK® mortar**

Characteristic	Performance
Compressive strength	M 20
Adhesion by shearing	0.15 N/mm <sup>2</sup>
Chloride content	Max. 0.02 %
Fire reaction	A1
Water absorption	0,04 kg/m <sup>2</sup> min <sup>0.5</sup>
Water vapour diffusion resistance	15 / 35
Average thermal conductivity	1.17 W/m.K
Volume mass	1950 kg/m <sup>3</sup>

#### 4 Marmox THERMOBLOCK® components

Marmox THERMOBLOCK® components are made from extruded polystyrene foam (XPS) or polyisocyanurate foam (PIR) insulation material. Cylindrical holes are drilled into them at regular intervals, according to the required dimensions. These holes are filled with a polymer-modified concrete. The cylinders formed in this way give the component its load-bearing capacity. The lower and upper sides of the component are coated with a 2 mm-thick polymer-modified mortar, with an alkali-resistant double glass fibre mesh. A profile is milled at the ends of the component, so that a full covering can be obtained when they are laid.

**Fig. 1: Composition of MARMOX THERMOBLOCKS**

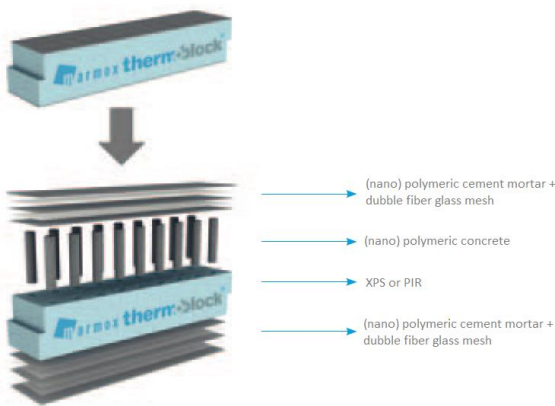

The different types are shown in the following diagrams.

**Fig. 2: Different types of Marmox THERMOBLOCK®**

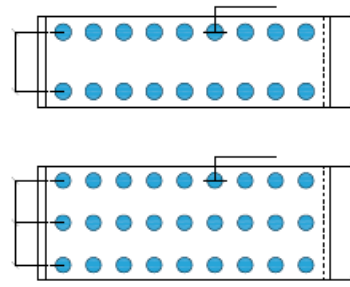
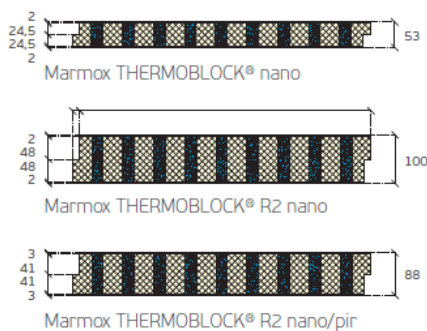

**Table 7 – Properties of Marmox THERMOBLOCKS®**

Characteristic	Method	MT®nano	MT®R2nano	MT®R2nano/ pir
Length	NBN EN 772-16	615 mm ± 1 mm		
Usable length		600 mm ± 1 mm		
Width		90-100-120-140-150-190-214-240-290 ± 1 mm		
Height		53 mm +2/-4 mm	100 mm +2/-4 mm	88 mm +2/-4 mm
Insulation material thickness	NBN EN 823	49 mm	96 mm	82 mm
Parallelism	NBN EN 772-16	2 mm	2 mm	2 mm
Cylinder diameter		See table 8 ± 2 mm		
Volume ratio of polymer concrete / insulation material		15 / 85		
Thermal conductivity λ <sub>D</sub>	NBN B 62-002	0,047 W/mK	0,047 W/mK	0,041 W/mK
Thermal resistance R <sub>D</sub>	NBN B 62-002	1 m <sup>2</sup> K/W	2 m <sup>2</sup> K/W	2 m <sup>2</sup> K/W
Average compressive strength (50/95)	NBN EN 772-1	7.5 N/mm <sup>2</sup>	7.5 N/mm <sup>2</sup>	7.5 N/mm <sup>2</sup>
Density	NBN EN 1602	600 kg/m <sup>3</sup>		

**Table 8 – Characteristics of the cylinder**

Width (mm)	Number of rows of cylinders (-)	Number of cylinders (-)	Cylinder diameter (mm)
90	2	18	24
100	2	18	25
120	2	18	28
140	2	18	30
150	2	18	31
190	2	18	35
214	3	27	30
240	3	27	32
290	3	27	35

#### 5 Manufacture and marketing

Marmox THERMOBLOCKS® are marketed by Albintra nv and produced by CMB at a production site known to the UBAtc.

#### 6 Labelling, packaging and storage

##### 6.1 Labelling

The Marmox Thermoblock brand is printed on the components (see Fig. 1:).

The packaging also lists the following information: date of manufacture, dimensions, number of components per package and R value.

## 6.2 Packaging

Marmox THERMOBLOCKS® are packed in crates, according to Tabel 9 below.

**Tabel 9 – Quantities per crate**

Width (mm)	MT® nano (m/box)	MT® R2 nano (m/box)	MT® R2 nano/pir (m/box)
90 mm	14.4	9.0	9.6
100 mm	12.6	7.2	9.6
120 mm	10.8	7.2	7.8
140 mm	8.4	5.4	6.0
150 mm	8.4	4.8	6.0
190 mm	6.6	3.6	4.8
214 mm	5.4	3.6	4.8
240 mm	4.8	3.0	3.6
290 mm	4.2	2.4	3.0

Marmox THERMOBLOCK® mortar is packed in 25 kg polyethylene bags with a shelf life of 12 months.

## 7 Performance

The performance of brick walls, which include a layer of load-bearing Marmox THERMOBLOCKS®, is determined on the basis of the results of type tests conducted in approved laboratories.

### 7.1 Characteristic resistance to compression

The characteristic compressive strength of walls made from clay bricks for non-decorative masonry, which include load-bearing Marmox THERMOBLOCKS®, has been examined by means of tests conducted on low walls in compliance with NBN EN 1052-1 and on 2.4 m high walls subject to eccentric loads.

#### 7.1.1 Compression tests conducted on a combination of Marmox THERMOBLOCKS® and clay bricks for non-decorative masonry

An initial series of compression tests was conducted, as follows:

- 600x140x53 Marmox (10/90) THERMOBLOCKS® containing 10% x 20 mm diameter mortar cylinders, average compressive strength tested on 10 components: 6.35 N/mm<sup>2</sup>;
- 600x140x100 Marmox THERMOBLOCKS® (15/85) containing 15% x 30 mm diameter mortar cylinders, average compressive strength tested on 10 components: 9.1 N/mm<sup>2</sup>;
- clay bricks for non-decorative masonry, dimensions: 495 x 140 x 238 and average compressive strength tested on 10 bricks: 14.1 N/mm<sup>2</sup>;
- clay bricks for non-decorative masonry, dimensions: 288 x 138 x 188 and average compressive strength tested on 10 bricks: 28.2 N/mm<sup>2</sup>;
- M10 mortar.

The test results are shown in Tabel 10.

Tests on the combination of Marmox THERMOBLOCKS® + clay bricks (see Fig. 3:), conducted on 10 combinations and in compliance with NBN EN 772-1, produced the results shown in Tabel 10.

**Tabel 10 – Marmox block/brick combinations**

Type of masonry brick	Brick: 14,1 N/mm <sup>2</sup>		Brick: 28,2 N/mm <sup>2</sup>	
	Average compressive strength 50/50	Characteristic compressive strength 95/75	Average compressive strength 50/50	Characteristic compressive strength 95/75
	(N/mm <sup>2</sup> )	(N/mm <sup>2</sup> )	(N/mm <sup>2</sup> )	(N/mm <sup>2</sup> )
Marmox 10/90 thickness 53 mm	3.1	2.5	4.4	3.6
Marmox 15/85 thickness 100 mm	4.3	3.8	6.1	5.5

Break pattern: cylinders pierce through the bricks

**Fig. 3: Configuration of the compression test combining Marmox THERMOBLOCKS® and high-speed building bricks**

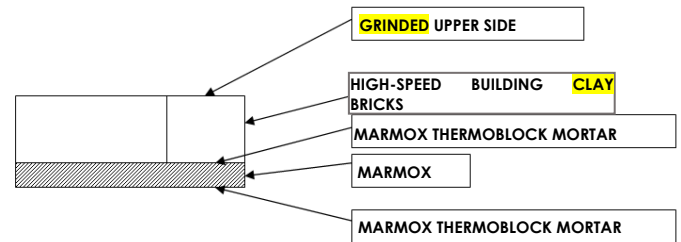

### 7.2 Compression tests on low walls

Compression tests on 3 low walls consisting of 14.1 N/mm<sup>2</sup> clay bricks for non-decorative masonry and Marmox THERMOBLOCK® base layer blocks (10/90, thickness: 53 mm) in compliance with NBN EN 1052-1, average dimensions: 746 mm x 140 mm x 1322 mm, produced the following results:

- Low wall M1: 3,5 N/mm<sup>2</sup>
- Low wall M2: 3,3 N/mm<sup>2</sup>
- Low wall M3: 3,7 N/mm<sup>2</sup>

This leads to the following result:

- An average of 3.5 N/mm<sup>2</sup>
- Characteristic compressive strength  $f_k$ : 2.8 N/mm<sup>2</sup>

Break pattern: the mortar cylinders essentially pierce through the bricks.

The following safety coefficient must be applied to these values, in order to determine the design values:

- Execution class S:  $\gamma = 2,0$
- Execution class N:  $\gamma = 2,5$

Note:

- Execution class N (normal): continuous supervision of the qualified and experience employees of the company conducting the work and normal supervision of the designer;
- Execution class S (special): continuous supervision of the qualified and experience employees of the company conducting the work. Normal supervision is extended to include regular and frequent monitoring by qualified employees who are independent of the company conducting the work.

**7.2.1 The relevant combination produces the following calculation values:**

**Tabel 11 – Characteristics**

Characteristic	Execution class S (N/mm <sup>2</sup> )	Execution class N (N/mm <sup>2</sup> )
Design compressive strength $f_d$	1.4	1.12

**7.3 Compression tests on walls**

In order to check whether, based on the characteristic compressive strength as determined above, the permissible stresses calculated in compliance with the regulations of NBN EN 1996-1-1 + ANB or as indicated in STS 22 provide enough safety, tests have been conducted on walls with average dimensions of 2100 mm x 140 mm x 2322 mm.

- Two walls were tested, subject to an eccentric load (eccentricity of 30 mm) and an increased load in compliance with NBN EN 1052-1.

**Result:** rupture tension

- Wall M1: 2,7 N/mm<sup>2</sup>
- Wall M2: 3,1 N/mm<sup>2</sup>

**7.4 Conclusions**

**Conclusion 1:** The characteristic compressive strength of walls consisting of clay bricks for non-decorative masonry, including Marmox THERMOBLOCK® load-bearing blocks has been determined by means of tests conducted on low walls (see § 7.2). In order to determine, in a simple way, the characteristic compressive strength of low walls consisting of bricks used for non-decorative masonry including Marmox THERMOBLOCK® load-bearing blocks. Another possible method is based on tests conducted on 10 test pieces made from the bloc Marmox THERMOBLOCK® - brick combination, in compliance with NBN EN 772-1. The result is expressed as a characteristic compressive strength with 75% confidence level, calculated in compliance with document TR 16886. The above-mentioned test produces the following results:

- $F_k$ : 2,5 N/mm<sup>2</sup>
- $F_d$ : 1,25 N/mm<sup>2</sup> for execution class S
- $F_d$ : 1 N/mm<sup>2</sup> for execution class N

**Conclusion 2:** In order to calculate the permissible stresses for the vertical load according to eccentricities, slendernesses and moments present, the formulas from NBN EN 1996-1-1+ANB can be applied with the necessary caution, starting with the characteristic compressive strength of the masonry, as determined above.

Tabel 12 lists the results for the characteristic value and calculation value for compressive strength, determined according to the alternative method based on the combinations tested.

**Note:** as with any tests conducted on walls, it is also necessary, in this case, to conduct another verification at the top and centre of the wall, according to the rules of NBN EN 1996-1-1 + ANB.

**Tabel 12 – Marmox block/brick combinations**

Combination of masonry bricks	Characteristic resistance to compression (N/mm <sup>2</sup> )	Calculation value – execution class S (N/mm <sup>2</sup> )	Calculation value – execution class N (N/mm <sup>2</sup> )
Marmox 10/90 thickness: 53 mm + brick 14,1 N/mm <sup>2</sup>	2.5	1.2	1.0
Marmox 10/90 thickness: 53 mm + brick 28,2 N/mm <sup>2</sup>	3.6	1.8	1.4
Marmox 15/85 thickness: 100 mm + brick 14,1 N/mm <sup>2</sup>	3.8	1.9	1.5
Marmox 15/85 thickness: 100 mm + brick 28,2 N/mm <sup>2</sup>	5.5	2.7	2.2

**7.5 Shear strength**

The shear strength  $f_{vk0}$  of masonry consisting of bricks for non-decorative masonry, including Marmox THERMOBLOCK® load-bearing blocks, was determined by means of tests, according to Fig. 4:).

**Fig. 4: Configuration for the shear test**

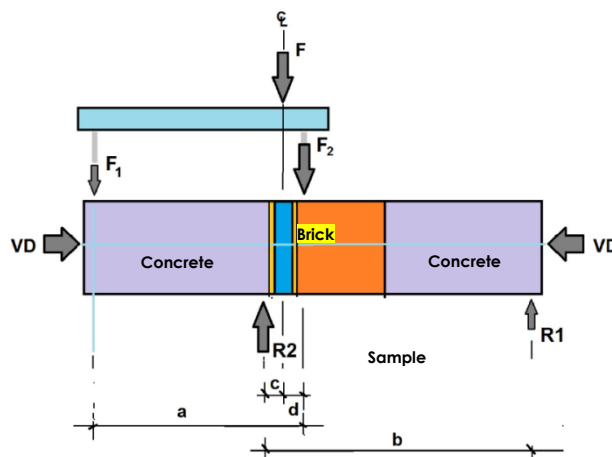

F, F1 and F2: stress  
VD: anterior pressure using 4 threaded rods  
R1 and R2: reactions

The situation was recreated with Marmox THERMOBLOCK® blocks, which were laid between a concrete surface (underlying) and the wall (built on blocks). The shear stress was adjusted so that the bending factor is minimal. This is a common way of testing the shear stress (Van Mier (1998), Triplet shear test (EC6)). The actuator force is designated by the letter F. This force produces, based on a balanced distribution of the latter, the forces F1 and F2 on the test piece. This stress gives rise to reactions R1 and R2. In this situation, the forces F1 and R1 are identical, along with forces F2 and R2. The tests were conducted at different anterior pressures. Key values for anterior pressures of 0.2 MPa, 0.6 MPa and 1.0 MPa were selected. The results are shown in graph form in Fig. 5: below.

The most appropriate rectitude was obtained for:  $y = 0.1971 x + 9.3785$ .

**Fig. 5: Graph**

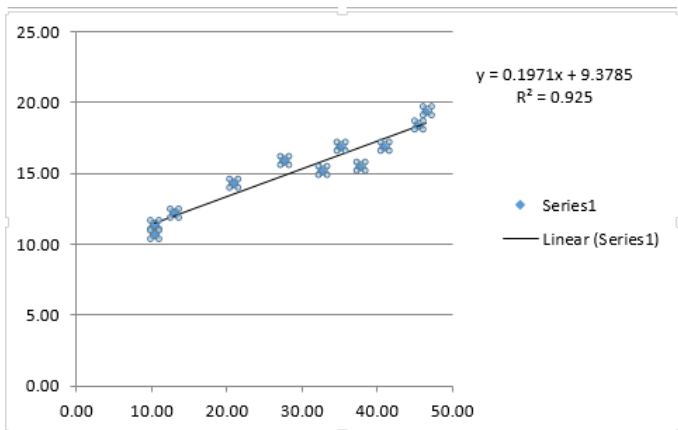

**Result:** characteristic shear strength  $f_{vk0} = 0.18 \text{ N/mm}^2$

## 7.6 Fire resistance

The fire resistance is determined on the basis of the test conducted on a wall subjected to a load in compliance with NBN EN 1365-1:2012.

The wall had the following dimensions: 3000 mm x 150 mm x 3000 mm.

The load applied to the wall was 39 kN/m ( $= 0.28 \text{ N/mm}^2$ ).

The test configuration was as follows (see also Fig. 6):

- 1) Marmox THERMOBLOCKS® applied to a layer of Marmox THERMOBLOCK® mortar;
- 2) Marmox mortar applied over and under the Marmox THERMOBLOCKS®;
- 3) A layer of high-speed building clay brick masonry of  $10 \text{ N/mm}^2$ ,  $850 \text{ kg/m}^3$ , percentage of hollow cavities: 50%. All vertical joints are filled with mortar;
- 4) Waterproof membrane, material: PE, thickness: 500  $\mu$ , width: 150 mm;
- 5) Once again, layer of masonry consisting of high-speed building clay bricks measuring  $10 \text{ N/mm}^2$ ,  $850 \text{ kg/m}^3$ , percentage of perforations: 50%. All vertical joints are filled with mortar;
- 6) Insulation material: PU, thickness: 100 mm, width: 355 mm, length: 2950 mm, volume mass:  $30 \text{ kg/m}^3$ ;
- 7) PE foam strip, thickness: 5 mm, height = thickness of the concrete floor;
- 8) Membrane, material: PE, thickness: 200  $\mu$ m. Position: between the floor insulation layer and the concrete screed + folded vertically between the foam strip and concrete screed;
- 9) Concrete screed: thickness: 125 mm, volume mass:  $1851 \text{ kg/m}^3$ , length: 2950 mm;
- 10) Layer coating of the Knauf MP 75 type, thickness: 15 mm, applied on the side exposed to the fire and only above the waterproof membrane;
- 11) Plinth: MDF, dimensions: 68 mm x 12 mm, mass per length unit: 0.611 kg/m, fixed to the coating using a mastic (see 12);
- 12) Tec7 type mastic: MS polymer adhesive without solvent.

**Fig. 6: Detailed configuration for the fire test**

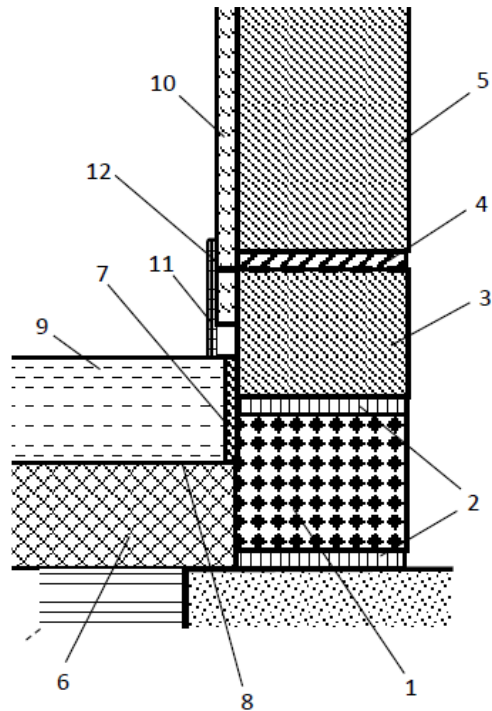

Results: see Tabel 13.

**Tabel 13 – Results of the fire test**

Observations	Excess
$\Delta T_m = 140 \text{ }^\circ\text{C}$	132 minutes
$\Delta T_m = 180 \text{ }^\circ\text{C}$	134 minutes, no rupture <sup>(1)</sup>
Radiation intensity = $15 \text{ kW/m}^2$	134 minutes, no rupture <sup>(1)</sup>
Cotton swab ignites	134 minutes, no rupture <sup>(1)</sup>
Spontaneous and continuous flames	134 minutes, no rupture <sup>(1)</sup>
Failure with 6 mm calibre	134 minutes, no rupture <sup>(1)</sup>
Failure with 25 mm calibre	134 minutes, no rupture <sup>(1)</sup>
Axial shortening $C=h/100 = 30 \text{ mm}$	134 minutes, no rupture <sup>(1)</sup>
Rate of axial shortening $dC/dt=3h/1000 = 9 \text{ mm/min}$	134 minutes, no rupture <sup>(1)</sup>
<sup>(1)</sup> : The test was interrupted after 134 minutes	

**Classification of the configuration, as used for the fire test:** the classification was made in compliance with NBN EN 13501-2 + A1: 2009 § 7: REI 120, REW 120, RE 120, R 120.

**Note:** the classification mentioned is only valid for the configuration used for the test.

## 8 Construction and use

The construction of masonry made from bricks for non-decorative masonry, including load-bearing Marmox THERMOBLOCKS®, must be in compliance with the regulations listed in the following documents:

- NBN EN 1996-1-1 + ANB
- NBN EN 1996-2 + ANB
- STS 22
- Instructions for use issued by the manufacturer and approved by the BCCA

## 9 Conditions

- A.** This Technical Approval refers exclusively to the system mentioned on the cover page of the Technical Approval.
- B.** Only the approval holder and, if applicable, the distributor may assert rights based on the technical approval.
- C.** The approval holder and, if applicable, the distributor are not permitted, in any way, to use the name of the UBAtc, its logo, the ATG mark, the technical approval or the approval number to demand the evaluation of products that fail to comply with the technical approval or products, equipment or systems, including their properties or characteristics, which do not form the object of the technical approval.
- D.** Information provided in any way by the Approval Holder, distributor or an approved contractor or by their representatives for (potential) users of the system, which is described in the Technical Approval (e.g. for clients, contractors, architects, consultants, designers, etc.) must not be incomplete or contradict the content of the Technical Approval or information mentioned in the Technical Approval.
- E.** The Approval Holder is bound at all times to provide UBAtc, the Approval Body and the Certification Body with prompt or prior notification of any adjustments made to primary materials and products, installation instructions and/or the manufacturing, installation and equipment process. According to the information communicated, the UBAtc, the approval body and the certification body will judge whether it is necessary to adjust the technical approval.
- F.** The Technical Approval is based on the available knowledge and technical/scientific information, together with information provided by the applicant and complemented by an approval inspection, which takes account of the specific nature of the system. However, users remain responsible for selecting the system, as described in the Technical Approval, for the specific use intended by the user.
- G.** The intellectual property rights associated with the Technical Approval, including the copyright, belong exclusively to the UBAtc.
- H.** Any references to the technical approval must be accompanied by an ATG index (ATG 3093) and the validity period.
- I.** The UBAtc, the approval body and the certification body cannot be held responsible for any damage or adverse consequences suffered by third parties (e.g. the user) that result from the failure of the approval holder or distributor to respect the provisions of Article 9.



UBAAtc asbl is an approval body and member of the European Union for Construction Approval (UEAtc, see [www.ueatc.eu](http://www.ueatc.eu)) notified by the FPS Economy within the framework of Regulation 305/2011/EEC and member of the European Organisation for Technical Approvals (EOTA, see [www.eota.eu](http://www.eota.eu)). Certification bodies designated by UBAAtc asbl operate in compliance with a system that is set to be accredited by BELAC ([www.belac.be](http://www.belac.be)).



This technical approval has been published by UBAAtc, under the responsibility of the approval body BCCA, and based on favourable feedback from the specialist "MAIN STRUCTURE AND CONSTRUCTION SYSTEMS" group, issued on July 10th 2017.

In addition, the BCCA certification body has confirmed that the production process meets the conditions for certification and that a certification agreement was signed by the ATG holder.

Date of issue: 9 January 2018.

For UBAAtc, declaration of the validity of the approval process

Peter Wouters, director

For the approval and certification body

Benny De Blaere, Managing director

This Technical Approval shall remain valid, provided the system, its manufacture and all processes that are appropriate for this purpose:

- are maintained, in order to achieve, as a minimum, the inspection results defined in the approval document;
- are continuously monitored by the Certification Body, which confirms that the certification continues to be valid;

If these conditions are no longer met, the technical approval shall be suspended or withdrawn and the approval document shall be deleted from the UBAAtc website. The technical approvals are regularly updated. It is recommended that you always use the version published on the UBAAtc website ([www.ubatc.be](http://www.ubatc.be)).

The most recent version of the technical approval can be consulted using this QR code.

